

Exploded diagram and spare parts list

For machines with - CF761-A-04

[Click](#)









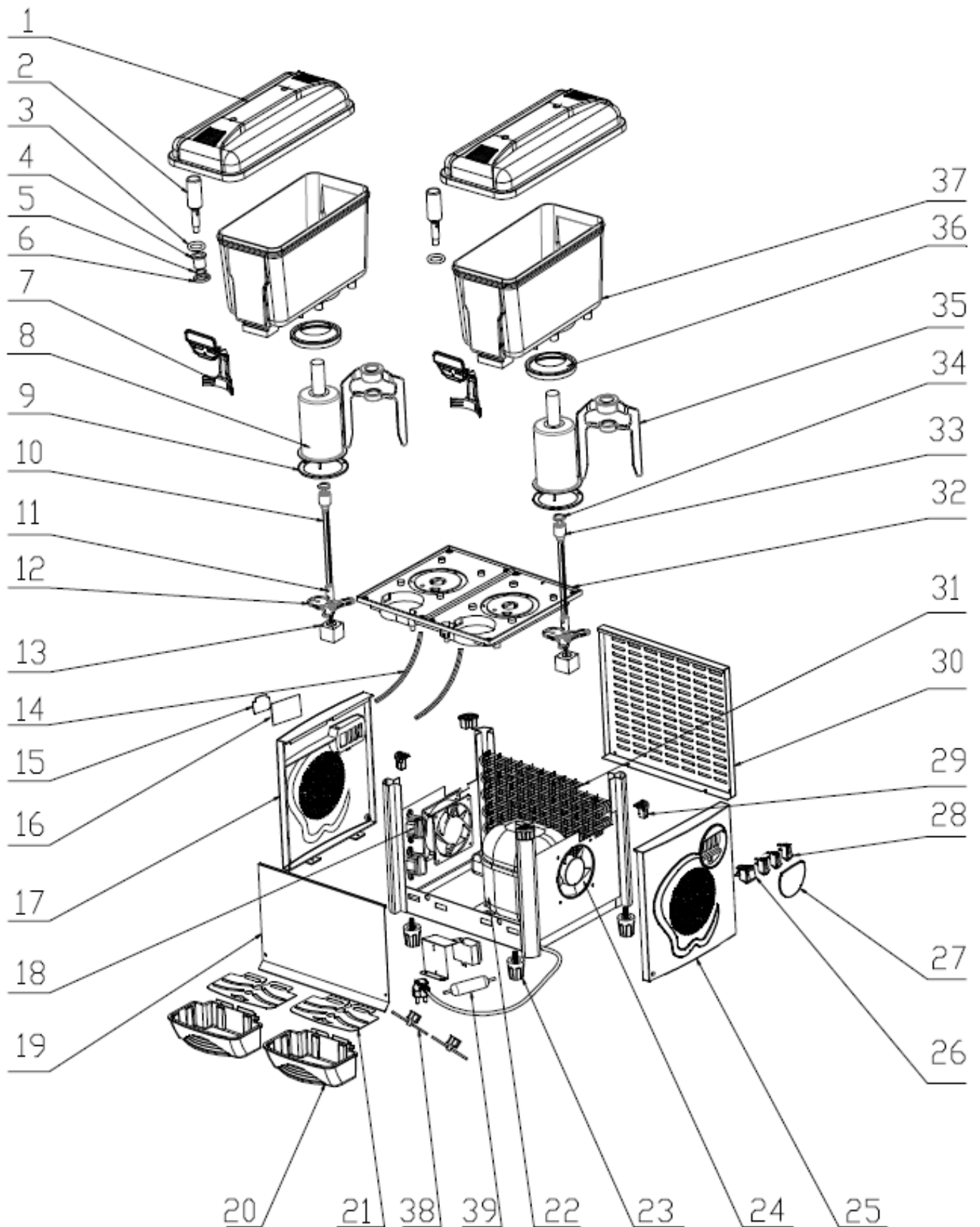













From 401177-AU(S/N:KL191621906D1724~KL191621906D1755),
onward

For machines with – CF761-A

[Click](#)

Prior to 401177-AU(S/N:KL191621906D1724~KL191621906D1755)





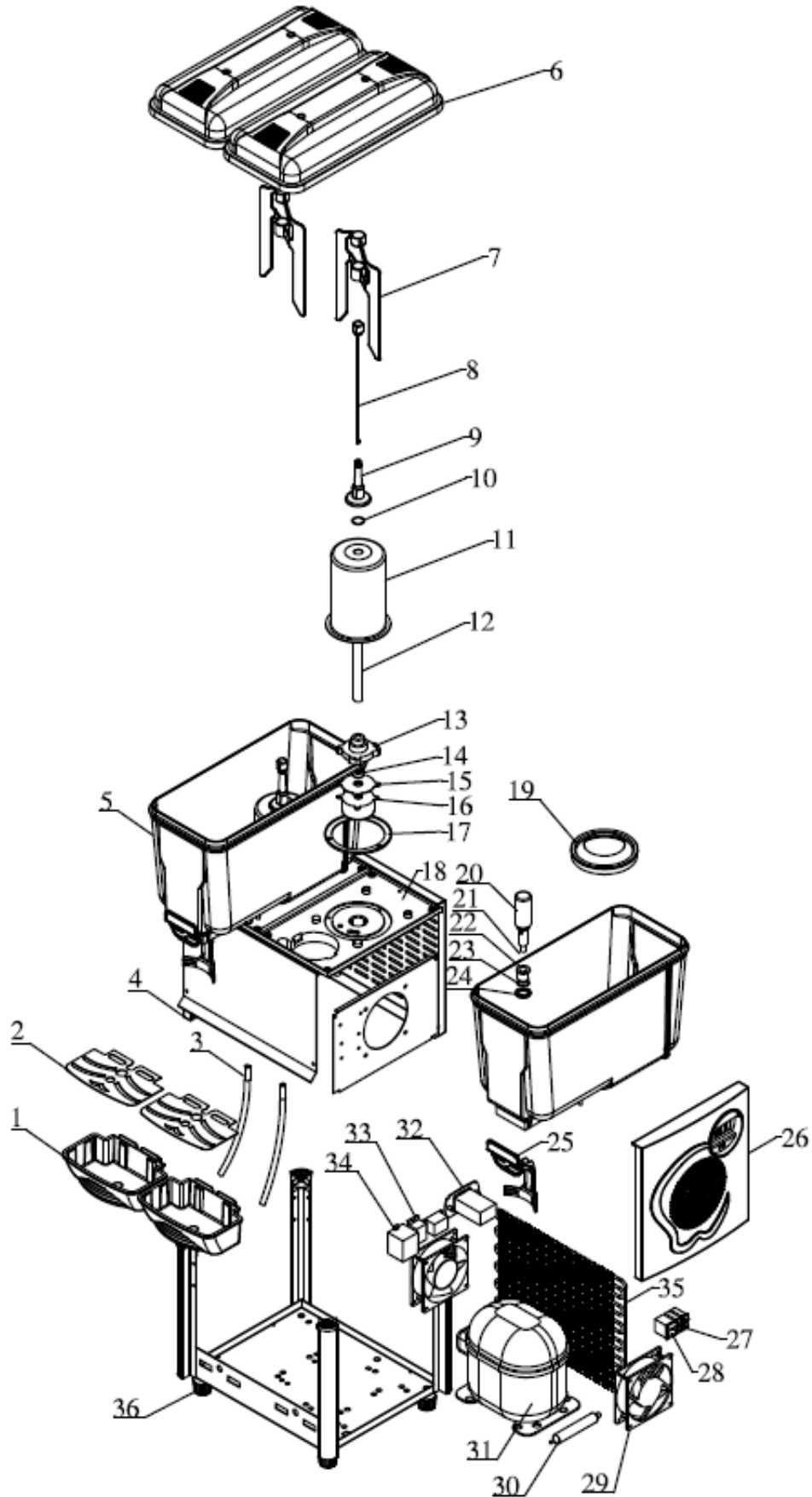











Machine	Explode	Code	Description
Polar Double Chilled Drinks Dispenser Grey	1	AJ201	Cover
Polar Double Chilled Drinks Dispenser Grey	2	AB933	Stainless Steel Valve
Polar Double Chilled Drinks Dispenser Grey	3	AB555	Tap Gasket
Polar Double Chilled Drinks Dispenser Grey	4		Outlet
Polar Double Chilled Drinks Dispenser Grey	5		Seal of Outlet
Polar Double Chilled Drinks Dispenser Grey	6		Screw of Outlet
Polar Double Chilled Drinks Dispenser Grey	7	AG909	Tap Lever
Polar Double Chilled Drinks Dispenser Grey	8		Tank Evaporator - From 401177-AU
Polar Double Chilled Drinks Dispenser Grey	9		Washer of Evaporator
Polar Double Chilled Drinks Dispenser Grey	10		Mixing Pod - From 401177-AU
Polar Double Chilled Drinks Dispenser Grey	11		Driveshaft Coupler - From 401177-AU
Polar Double Chilled Drinks Dispenser Grey	12		Motor Mounting Plate - From 401177-AU
Polar Double Chilled Drinks Dispenser Grey	13	AK040	Stepped Motor - From 401177-AU
Polar Double Chilled Drinks Dispenser Grey	14		Drain Pipe
Polar Double Chilled Drinks Dispenser Grey	15	AK041	Thermostat Sticker for Left Side Panel-From 401177-AU
Polar Double Chilled Drinks Dispenser Grey	15		Thermostat Sticker for Right Side Panel-From 401177-AU
Polar Double Chilled Drinks Dispenser Grey	16	AK043	Thermostat for ABS Left Side Panel-From 401177-AU
Polar Double Chilled Drinks Dispenser Grey	16		Thermostat for S/S Right Side Panel-From 401177-AU
Polar Double Chilled Drinks Dispenser Grey	17		Left Side Panel of Controller Side
Polar Double Chilled Drinks Dispenser Grey	18	AK044	Transformer - From 401177-AU
Polar Double Chilled Drinks Dispenser Grey	19		Front Plate
Polar Double Chilled Drinks Dispenser Grey	20	AJ070	Water Tray
Polar Double Chilled Drinks Dispenser Grey	21	AJ200	Lid of Water Tray
Polar Double Chilled Drinks Dispenser Grey	22	AG672	Compressor (R290)
Polar Double Chilled Drinks Dispenser Grey	23		Adjustable Feet
Polar Double Chilled Drinks Dispenser Grey	24	AJ202	Condenser Fan Motor
Polar Double Chilled Drinks Dispenser Grey	25		Right Side Panel
Polar Double Chilled Drinks Dispenser Grey	26	AE596	Power Switch
Polar Double Chilled Drinks Dispenser Grey	27		Cover for Switch
Polar Double Chilled Drinks Dispenser Grey	28	AE841	Switch for Motor
Polar Double Chilled Drinks Dispenser Grey	29		Corner Plug
Polar Double Chilled Drinks Dispenser Grey	30		Back Panel
Polar Double Chilled Drinks Dispenser Grey	31		Condenser
Polar Double Chilled Drinks Dispenser Grey	32		Roof
Polar Double Chilled Drinks Dispenser Grey	33		Rotor - From 401177-AU
Polar Double Chilled Drinks Dispenser Grey	34		Rotor Positioning Plate - From 401177-AU
Polar Double Chilled Drinks Dispenser Grey	35	AK045	Paddle - From 401177-AU
Polar Double Chilled Drinks Dispenser Grey	36	AB557	Tank Gasket
Polar Double Chilled Drinks Dispenser Grey	37	AJ071	High-Density PC Bowl (Paddle System)
Polar Double Chilled Drinks Dispenser Grey	38	AK046	Electronic Expansive Valve & Coil - From 401177-AU
Polar Double Chilled Drinks Dispenser Grey	39	AG674	Filter Drier



Exploded diagram and spare parts list

(CF761-A)

Machine	Explode	Code	Description
Polar Double Chilled Drinks Dispenser Grey	1	AJ070	Water Tray
Polar Double Chilled Drinks Dispenser Grey	2	AJ200	Lid of Water Tray
Polar Double Chilled Drinks Dispenser Grey	3		Drain Pipe
Polar Double Chilled Drinks Dispenser Grey	4		Left Side Panel
Polar Double Chilled Drinks Dispenser Grey	5	AJ071	High-Density PC Bowl (Paddle System)
Polar Double Chilled Drinks Dispenser Grey	6	AJ201	Cover
Polar Double Chilled Drinks Dispenser Grey	7	AB553	Mixing Paddle
Polar Double Chilled Drinks Dispenser Grey	8	AB558	Mixing Paddle Rod
Polar Double Chilled Drinks Dispenser Grey	9		Mixing Pod
Polar Double Chilled Drinks Dispenser Grey	10		Seal of Rod In Evaporator
Polar Double Chilled Drinks Dispenser Grey	11		Tank Evaporator
Polar Double Chilled Drinks Dispenser Grey	12		Rod In Evaporator
Polar Double Chilled Drinks Dispenser Grey	13	AB560	Cock of Mixing Motor
Polar Double Chilled Drinks Dispenser Grey	14		Seal of Mixing Motor
Polar Double Chilled Drinks Dispenser Grey	15		Cover of Mixing Motor
Polar Double Chilled Drinks Dispenser Grey	16		Mixing Motor
Polar Double Chilled Drinks Dispenser Grey	17		Washer of Evaporator
Polar Double Chilled Drinks Dispenser Grey	18		Roof
Polar Double Chilled Drinks Dispenser Grey	19	AB557	Tank Gasket
Polar Double Chilled Drinks Dispenser Grey	20	AB933	Stainless Steel Valve
Polar Double Chilled Drinks Dispenser Grey	21	AB555	Tap Gasket
Polar Double Chilled Drinks Dispenser Grey	22		Outlet
Polar Double Chilled Drinks Dispenser Grey	23		Seal of Outlet
Polar Double Chilled Drinks Dispenser Grey	24		Screw of Outlet
Polar Double Chilled Drinks Dispenser Grey	25	AG909	Tap Lever
Polar Double Chilled Drinks Dispenser Grey	26		Right Side Panel
Polar Double Chilled Drinks Dispenser Grey	27	AE841	Switch for Mixing Motor
Polar Double Chilled Drinks Dispenser Grey	28	AE596	Power Switch
Polar Double Chilled Drinks Dispenser Grey	29	AJ202	Fan Motor
Polar Double Chilled Drinks Dispenser Grey	30	AG674	Filter Drier
Polar Double Chilled Drinks Dispenser Grey	31	AG672	Compressor(R290)
Polar Double Chilled Drinks Dispenser Grey	32	AJ203	Thermostat
Polar Double Chilled Drinks Dispenser Grey	33	AJ204	Relay
Polar Double Chilled Drinks Dispenser Grey	34	AJ069	Transformer
Polar Double Chilled Drinks Dispenser Grey	35		Condenser
Polar Double Chilled Drinks Dispenser Grey	36		Adjustable Leg