



Pie Cabinet

CPC/CPC1



British Built for Purpose.





Welcome to Parry

Parry is one of the UK's foremost manufacturers of high-quality Stainless Steel Fabricated Products with a 40-year heritage rooted in British craftsmanship.

At Parry, quality and service are second nature. Striving to exceed our customers' expectations is not just our motto; it's the very heartbeat of our business. Our commitment to our customers is reflected in the **Parry 4E Standard Inspection Body** stating that all our products are:



Easy to use



Easy to maintain



Easy to clean



Easy to repair

Our ranges of Stainless Steel Products have been specifically designed with the consumer in mind and are tailored and compliant to your specific industry sector. All our products are 4E Compliant and meet EU & UK regulations, where applicable. The Parry brand stands for quality, reliability and value.

Our British designed products have been created by our expert in-house development team and manufactured to exacting standards using Industry specified grade of European stainless steel and holding relevant EU & UK certification for all product.

ISO9001 certification and continual investment in the training and development of our highly skilled, artisan workforce means that our clients have genuine peace of mind that they are buying hand crafted, quality products supported by five-star customer service. All Parry products meet EU regulations for their respective sector.

We are LEAN manufacturers, minimising waste, maximising productivity. We are proud to run an operation that is committed to minimising our impact on the environment.

Our equipment and furniture are manufactured in our 45,000 sq ft manufacturing facility in Draycott, Derbyshire in England's industrial heartland. Products are made to order if not available in our stocked items which means you can choose from 600 products, offering over 3,500 variants, with short lead times to suit your specific needs. That means you get exactly what you need when you need it.

Our product information can be found here, in our brochure or on our website www.parry.co.uk.

You have my personal commitment that Parry will exceed your expectations. Should you have any questions please contact your distributor. Alternatively, our customer services team will be happy to help you on **01332 875544**.

Mark Banton MBA
Managing Director



Contents







Contents.....	1
Product Overview	2-3
Safety Instructions	4
Installation Instructions	4
Operating Instructions	5
Cleaning Instructions	6
Maintenance Instructions.....	6
Fault Finding	7
Service Information.....	7
Wiring Diagram	8
Exploded View	9
Parts List	10
Warranty Information.....	11
Disposal & Recycling	12

Parry Catering Equipment (Midlands) Ltd, Town End Road, Draycott, Derby, DE72 3PT.
Sales Tel: 01332 875544







Product Overview

Constructed with a robust stainless steel frame for reliable storage space and easy cleaning, this Parry Modular Heated Pie Cabinet can accommodate up to 60 freshly baked pies hygienically without losing the customer's view of the product. Any of the two/three wired shelves can be removed for cleaning and to fit larger stock, with all interior content being accessed through rear sliding doors at any time during service. A removable water reservoir is used within the cabinet to keep your pies from drying out.

-  Thermostatically controlled
-  Sliding doors to control side and solid glass to front
-  Supplied with a water reservoir to aid humidity
-  Manufactured from high grade stainless steel
-  Chrome wire shelves holding 20 pies per shelf, unit also includes an internal light
-  Supplied on a 13amp plug



It leads the industry in:

-  Design and aesthetic appeal
-  Performance
-  Power
-  Functionality
-  After sales support









Product Overview

	CPC	CPC1
Unpacked weight (kg)	22	31
Packet weight (kg)	25	35
Dimensions (w x d x h) mm	750 x 360 x 455	750 x 360 x 545
Warranty	2 Years	2 Years
Overall power rating	727W	727W
Plug	1	1



Safety Instructions

This appliance has been designed to warm products and therefore during its use parts of the appliance will become very hot. All personnel must be given appropriate supervision and training in the safe use of this appliance.







-  All appliances other than those supplied with a sealed moulded plug must be fitted with a sealed moulded plug by a qualified electrician, in accordance with current regulations.
-  The unit should be installed in compliance with the Installation Instructions and the National regulations in force at the time. Particular attention should be paid to the Health and Safety at Work Act.
-  To prevent shocks, all appliances whether gas or electric, must be earthed.
-  To avoid scratching of the unit, the protective film on the exterior surfaces has NOT been removed, this is to protect the highly polished exterior whilst in transit.
-  It is IMPORTANT that this protective film is peeled off before the equipment is used.
-  Ensure that vents intended to provide air flow in and around the unit are not obstructed.
-  Ensure the appliance is isolated from the power supply before installing, cleaning or maintaining the appliance



Installation Instructions

It is important that all protective film is removed from the unit and all packaging materials disposed of before use.

Ensure the unit is positioned on a flat surface.

-  Carefully slide the front glass into the supports on the front of the unit.
-  Put the element guard in place over the element, with the cut out for the humidity tray towards the back of the unit.
-  Place the humidity tray into the cut out in the element tray.
-  Hook the shelf supports into the cut outs on the inner sides of the unit.
-  Slide the wire shelves into the unit so that they rest on the shelf supports.
-  Take one of the doors and push it up into the inner channel at the top of the unit and holding the door vertical drop into the channel at the bottom.
-  Repeat last procedure with the remaining door to fill the outer channel. The doors should freely slide from left to right.











Operating Instructions

The unit is designed to keep food warm whilst serving and should never be used to try to cook food. All pies must be cooked before being placed in the warmer in accordance with pie manufacturer's instructions.

Control Thermostat

The thermostat controls the element. The setting for this is best determined by experience and depends on the quality of food in the unit and the environment.









Operation

-  Plug the unit in and switch on at power supply; interior lamp and red lamp will both illuminate.
-  Turn the temperature dial to the required setting the green lamp will show, indicating power to the element, and will extinguish when the desired temperature is reached.
-  This procedure will be repeated automatically as the thermostat maintains a constant temperature.
-  It is advisable to preheat the warmer for 30mins before placing hot product into the unit.
-  The element guard contains a water reservoir which can be filled to help keep the stored food moist.
-  Under no circumstances must the element or racks be covered over, i.e. wrapped in foil, or blocked with a plate.
-  Ensure the door is kept closed between each serving to keep heat loss to a minimum.
-  Wipe down regularly with soapy water after switching off and disconnecting from the power supply.



Cleaning Instructions

The appliance should be cleaned after every use.

-  Allow unit to cool down before emptying or cleaning.
-  Turn off unit at the mains power.
-  Remove glass doors, slide the wire shelves out and wipe down.
-  Remove the water tray and empty.
-  Unhook the shelf supports from the sides of the unit, this will provide enough clearance to remove the element guard.
-  With the shelf supports from the sides and the element guard removed, wipe down the machine using a soft cloth. Abrasive materials should not be used under any circumstances.
-  Stainless steel cleaners may be used and cleaning instructions on the product must be adhered to.
-  Never clean the unit with water jets.



Maintenance Instructions

Ensure the appliance is isolated from the power supply before installing, cleaning or maintaining the appliance.

Maintenance and service must only be undertaken by a qualified electrician.



Parry Catering provides a complete after-sales service by offering the sales of spare parts directly to customers. Buying spares straight from the manufacturer allows customer to experience exceptional value and speedy delivery on all spare parts.

For more information on buying spares visit:

www.parry.co.uk/parry-commercial-catering-spares



Fault Finding

Fault	Check	Solution
No power to unit	Check that the main light comes on.	Turn on mains power
	Try another appliance in the socket and the socket is turned on	If the socket is working fine check the fuse in the plug of the appliance
		See an engineer to replace faulty switch, or bulb.



Service Information

This appliance should be routinely serviced to prolong its lifetime. Parry recommends that the appliance is serviced every 12 months by a Parry authorised engineer. Failure to service your product within the initial 12-month warranty period will cause the 24-month warranty to become void.

If the supply cord becomes damaged, it must be replaced by the manufacturer, it's service agent, or a similarly qualified person.

Enhanced 2 Years Warranty

Parry Catering (Midlands) Ltd offer an enhanced warranty of two years (including parts and labour) on all of the Parry manufactured products. To take advantage of this you should register your warranty by logging onto the company website and filling out our simple form. www.parry.co.uk/the-parry-warranty

If you have any issues with your product and wish to request a warranty call you can contact our friendly team who will organize a Parry approved service engineer to attend and fix your problem.

All warranty requests can be sent to warranty@parry.co.uk alternatively call our warranty department for technical assistance on **01332 875544**





Wiring Diagram

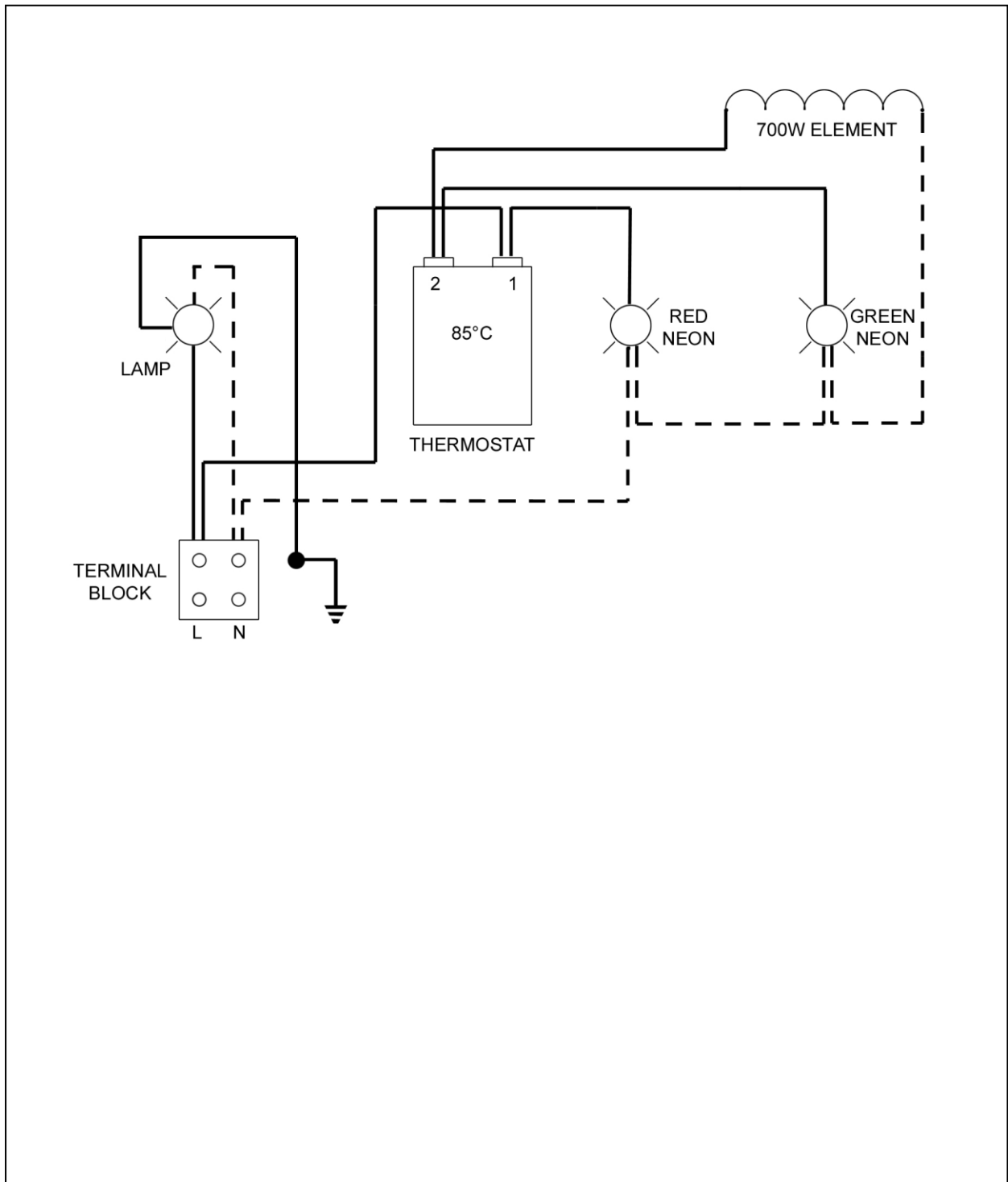



Exploded View

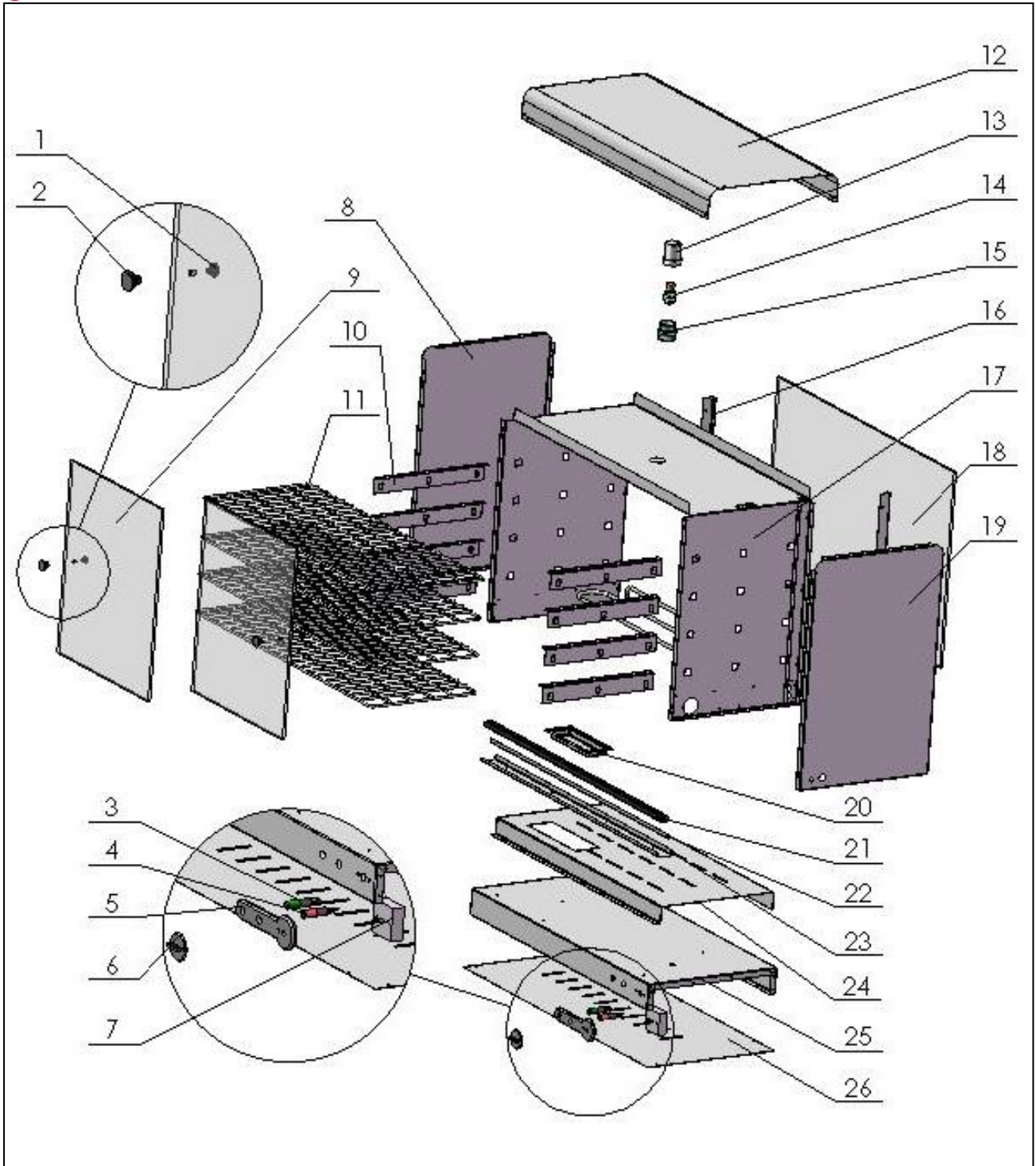



Parts List

Part Number	Description	CPC	CPC1
1	BLACK RUBBER MIRROR PLUG		WASHERPMC
2	DOOR HANDLE		KNBK11680
3	GREEN NEON		LNGN2211P
4	RED NEON		LNRE2211P
5	CONTROL BEZEL		BEZELCBOX
6	KNOB		KNOBTYPEB
7	THERMOSTAT		TMST13012
8	*OUTER RIGHT PANEL		
9	DOOR GLASS CPC	PLGL00368	PLGL00440
10	*SHELF SUPPORTS		
11	WIRE SHELF	TRPW00001	
12	*TOP		
13	BULB HOLDER	LAMP0027W (Capsule Lamp G9 27W 230-240V) Prior Serial No. 130101433 LAMP0015W (Small Eddison Screw Lamp E14 15W 230-240V)	LAMP0027W (Capsule Lamp G9 27W 230-240V) Prior Serial No. 130111702 LAMP0015W (Small Eddison Screw Lamp E14 15W 230-240V)
14	BULB		
15	BULB COVER		
16	*FRONT GLASS SUPPORTS (LEFT AND RIGHT)		
17	INNER BODY		
18	FRONT GLASS CPC	PLGL00349	PLGL00447
19	*OUTER LEFT PANEL CPC		
20	HUMIDITY TRAY	AS3481TRY	
21	*MIDDLE DOOR RAIL		
22	*SMALL DOOR RAIL		
23	*LARGE DOOR RAIL		
24	*ELEMENT COVER		
25	*BODY		

26

*BASE

*Metalwork Components



Warranty Information

The manufacturer's warranty is only valid in the UK mainland. Northern Ireland, Western Isles, Inner Hebrides and Islands are parts only warranty. Please be aware that the warranty starts from the date of purchase from Parry and not the sale or installation date of the equipment.

To be eligible for a 2-year warranty, products must be serviced at least once within the first 12 months of purchase.

All service calls will be carried out between 8am and 5pm, Monday to Friday.

Your warranty is invalid if your equipment has not been installed in accordance with the manufacturer's instructions. The misuse, alteration or unauthorised repairs of the equipment will also invalidate the warranty.

During the warranty period it is at Parry's discretion whether to repair or replace the equipment.

The warranty only applies if the equipment has been used in a professional manner following the manufacturer's instructions and maintenance guidelines.

The warranty covers defects in the material and component failure only. We are not liable for trading loss, loss of perishable items, water damage or loss due to injury or fire damage.

Please ensure you have referred to the manufacturer's instruction before placing a warranty call.

Contact our warranty department on **01332 875544** for technical assistance.











Please have your model number ready before calling.

All warranty requests must be submitted to warranty@parry.co.uk.

Failure to pay any warranty charges will result in your warranty being put on hold until the bill has been settled. Any issues regarding the raised charges should be put in writing to our warranty department for further investigation.

Register your product by visiting our website www.parry.co.uk

Not covered under warranty

-  Fault due to incorrect installation, poor maintenance or equipment abuse.
-  Resetting of equipment or circuit breakers.
-  Faulty electrics – e.g. customer's plug socket, plug, wiring, junction box fault, wrong fuse.
-  Products must be serviced within the first 12 months to be eligible for the 2-year warranty
-  Product not covered by warranty if combustible materials have been used, e.g. plastic trays.
-  Foil used on racks, blockages and lime scale issues.
-  Failure to grant access for pre-arranged service call.
-  Equipment that has been set up or used incorrectly e.g. dishwasher detergents, levelling and setting up of doors on a six-burner cooker.
-  Excessive carbon build-up on griddle plates or overuse of lava rock on chargrills. (Recommended use by Parry no more than 2kg.)
-  All of the above points are not covered by warranty and any costs incurred, because of the above, will be forwarded to the parties responsible for placing the call.



Disposal & Recycling

This appliance is marked according to the European Directive 2002/96/EC on Waste Electrical and Electronic Equipment (WEEE).

By ensuring this product is disposed of correctly, you will help prevent potential negative consequences for the environment and human health which could otherwise be caused by inappropriate waste handling of this product.

A symbol on the product, or on the documents accompanying the product, indicates that

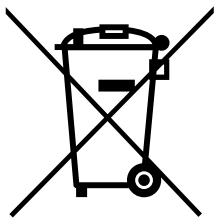

this appliance may not be treated as household waste. Instead it should be handed over to the applicable collection point for the recycling of electrical and electronic equipment.

Disposal must be carried out in accordance with local environmental regulations for waste disposal.





For more detailed information about treatment, recovery and recycling of this product, please contact your local city office, your household waste disposal service or the shop where you purchased the product.

Parry Catering recognises our obligations to the EU DIRECTIVE covering the waste disposal of electrical and electronic equipment (WEEE). Parry Catering are committed to this policy in order to help conserve the environment.

At the end of this unit's life you **MUST** dispose of it in an approved manner. You **MUST** not discard the unit or place it in the refuse bin.

You have several options:

-  Take the unit to an approved WEEE scheme company, there will be one in your area.
-  Take the unit to an approved waste disposal site; many sites are managed by your local authority.
-  Contact the unit's manufacturer, importer or their agent; the contact details will be on the unit.

There will probably be a charge for this service which will depend on the physical size and location of the unit. You will be given a collection price for a curb side collection based on commercial rates prevailing at the time.

It should be noted that the unit to be collected should be suitably packed and sealed to prevent dangerous gases and fluids from escaping. The condition of the unit must also be clean to comply with health and safety regulations.