

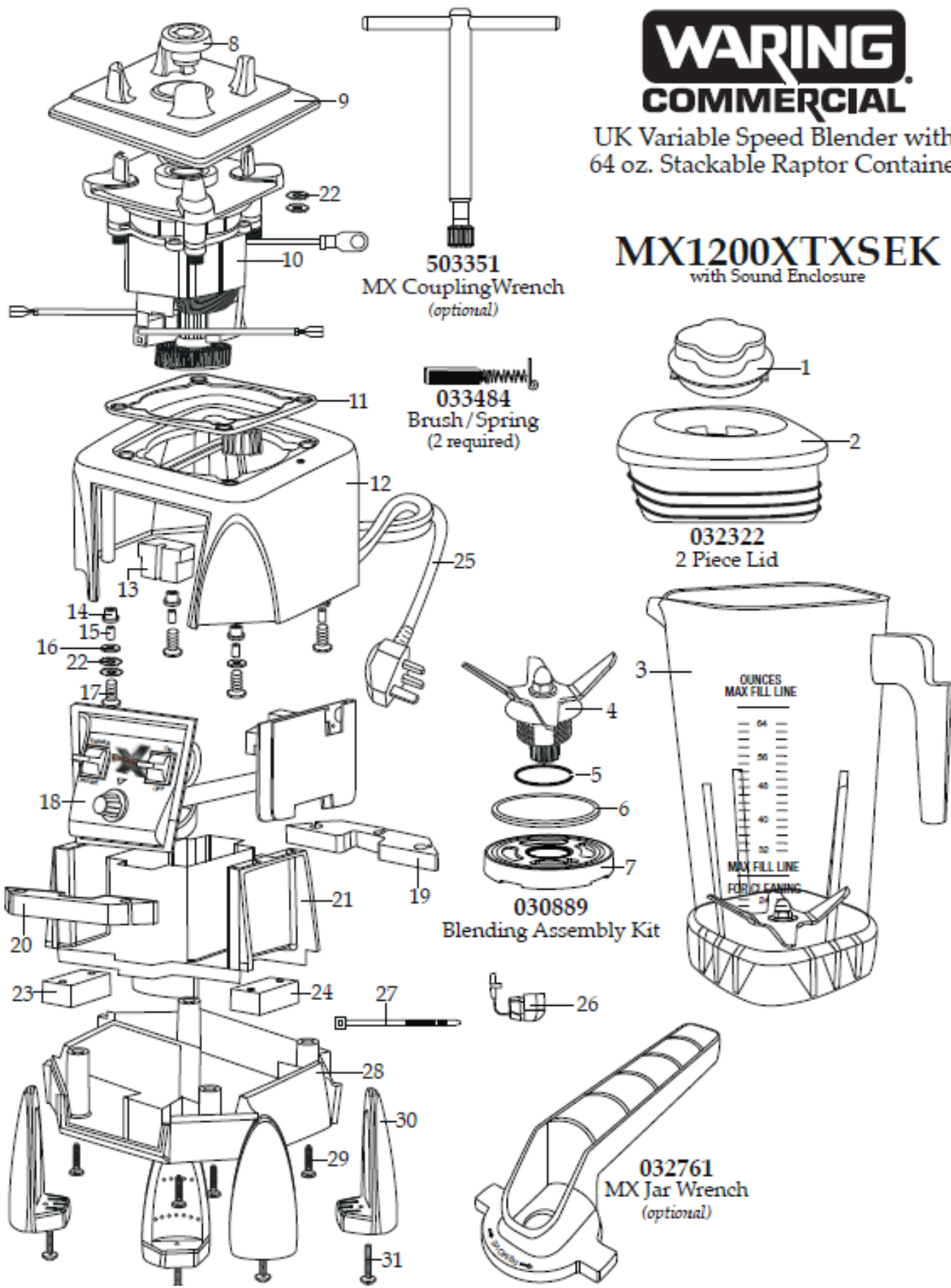































WARING
COMMERCIAL

UK Variable Speed Blender with
64 oz. Stackable Raptor Container

MX1200XTXSEK
with Sound Enclosure



Machine	Explode	Code	Description
Waring Xtreme X-Prep Blender	1	AF769	Jar Lid Cover
Waring Xtreme X-Prep Blender	2	AF768	Jar Lid
Waring Xtreme X-Prep Blender	3		Jar only (64 oz. stackable Raptor)
Waring Xtreme X-Prep Blender			Jar with Blending Assembly (64 oz. stackable Raptor)
Waring Xtreme X-Prep Blender	4		Blade assembly
Waring Xtreme X-Prep Blender	5		Bearing holder O ring
Waring Xtreme X-Prep Blender	6		Nut gasket
Waring Xtreme X-Prep Blender	7		Bearing holder nut
Waring Xtreme X-Prep Blender	8	AC930	Drive Clutch
Waring Xtreme X-Prep Blender	9		Jar Pad
Waring Xtreme X-Prep Blender	10		Motor
Waring Xtreme X-Prep Blender	11		Dampening Plate Gasket
Waring Xtreme X-Prep Blender	12		MX Housings, Ferrite Core & Cord (units after January 2014)
Waring Xtreme X-Prep Blender			Black Top Housing
Waring Xtreme X-Prep Blender	13		Motor Foam (2 required)
Waring Xtreme X-Prep Blender	14		Dampening Plate Bushing (4 required)
Waring Xtreme X-Prep Blender	15		Dampening Plate Sleeve (4 required)
Waring Xtreme X-Prep Blender	16		Washer (2 required)
Waring Xtreme X-Prep Blender	17		Screw (4 required)
Waring Xtreme X-Prep Blender	18	AC940	Soft Start Control Panel (units before January 2013)
Waring Xtreme X-Prep Blender	19		Housing Foam Rear Baffle
Waring Xtreme X-Prep Blender	20		Housing Foam Front Baffle
Waring Xtreme X-Prep Blender	21		MX Housings, Ferrite Core & Cord (part of #12 above)
Waring Xtreme X-Prep Blender			Motor Housing (older units)
Waring Xtreme X-Prep Blender	22		Washer (3 required)
Waring Xtreme X-Prep Blender	23		Bottom Housing Foam Baffle
Waring Xtreme X-Prep Blender	24		Foam Baffle
Waring Xtreme X-Prep Blender	25		MX Housings, Ferrite Core & Cord (part of #12 above)
Waring Xtreme X-Prep Blender		AC934	Cord Set (older units)
Waring Xtreme X-Prep Blender	26		Strain relief
Waring Xtreme X-Prep Blender	27		Cable tie(3 required)
Waring Xtreme X-Prep Blender	28		MX Housings, Ferrite Core & Cord (part of #12 above)
Waring Xtreme X-Prep Blender			Black Bottom Housing (older units)
Waring Xtreme X-Prep Blender	29		Screw (4 required)
Waring Xtreme X-Prep Blender	30		Corner Post (4 required)
Waring Xtreme X-Prep Blender	31		Screw (4 required)

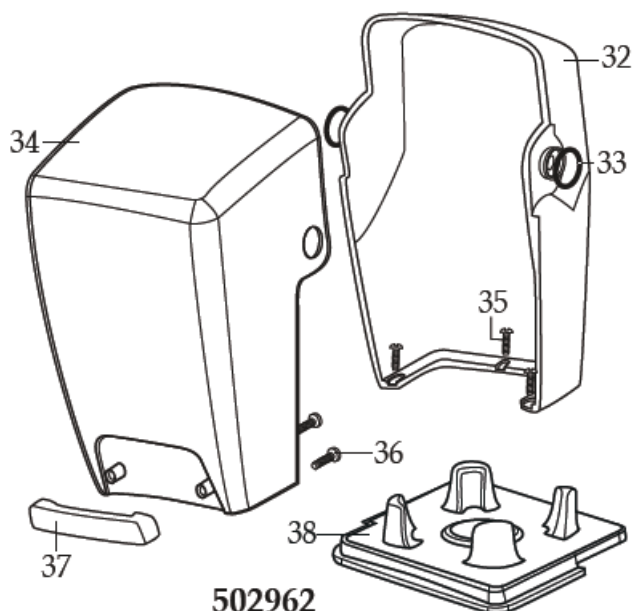

502962
SE1000 (Illustration# 32-38)

Waring Xtreme X-Prep Blender	32	WA329	64 oz. Inner Sound Enclosure
Waring Xtreme X-Prep Blender	33	☎	O Ring (2 required)
Waring Xtreme X-Prep Blender	34	☎	64 oz. Outer Sound Enclosure
Waring Xtreme X-Prep Blender	35	AC937	Screw (3 required)
Waring Xtreme X-Prep Blender	36	☎	Screw (2 required)
Waring Xtreme X-Prep Blender	37	☎	Sound Enclosure Handle
Waring Xtreme X-Prep Blender	38	☎	Sound enclosure jar pad
Waring Xtreme X-Prep Blender	503351	☎	MX Coupling Wrench
Waring Xtreme X-Prep Blender	032761	☎	MX Jar Wrench
Waring Xtreme X-Prep Blender	033484	033484	Brush/ Spring
Waring Xtreme X-Prep Blender	502962	☎	Sound Enclosure SE1000
Waring Xtreme X-Prep Blender	030889	☎	Blending Ass'y kit
Waring Xtreme X-Prep Blender	031060	AE166	Blending Ass'y kit
Waring Xtreme X-Prep Blender	Not shown	AC929	48oz Jar with Blending Assembly & lid
Waring Xtreme X-Prep Blender	Not shown	DM876	64oz Jar with Blending Assembly & lid